

PRODUCT DATA SHEET

N-Plug Cat 6A UTP Field Termination Plug

Product Details

Unscreened Category A/ Class EA Field Termination Plug, with 568A/B and PNO wiring label

Specifications

Comply with IEC 60603-7-41
 Plug Housing: PC FR
 Plug Pins: Phosphor bronze with 50u" gold plating
 Durability: 750 mechanical cycles
 Current rating: 1.5A
 Dielectric withstanding voltage: 1000V DC
 Insulation resistance: 500M Ω MIN.
 Contact resistance: 20m Ω MAX

Features

Transmission performance: Cat.6A /Class EA
 Wiring label: TIA 568A/B & PNO
 Termination capability:
 23~26 AWG solid wire
 23 ~27 AWG stranded wire
 Re-termination capability: 5 times
 Supporting cable diameter: 6~9mm
 UL Listed
 PoE+ compliant
 4PPoE compliant

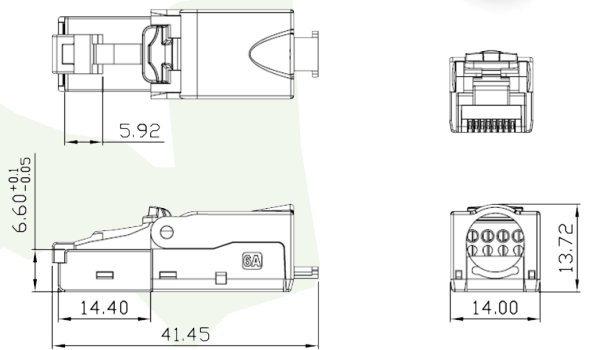

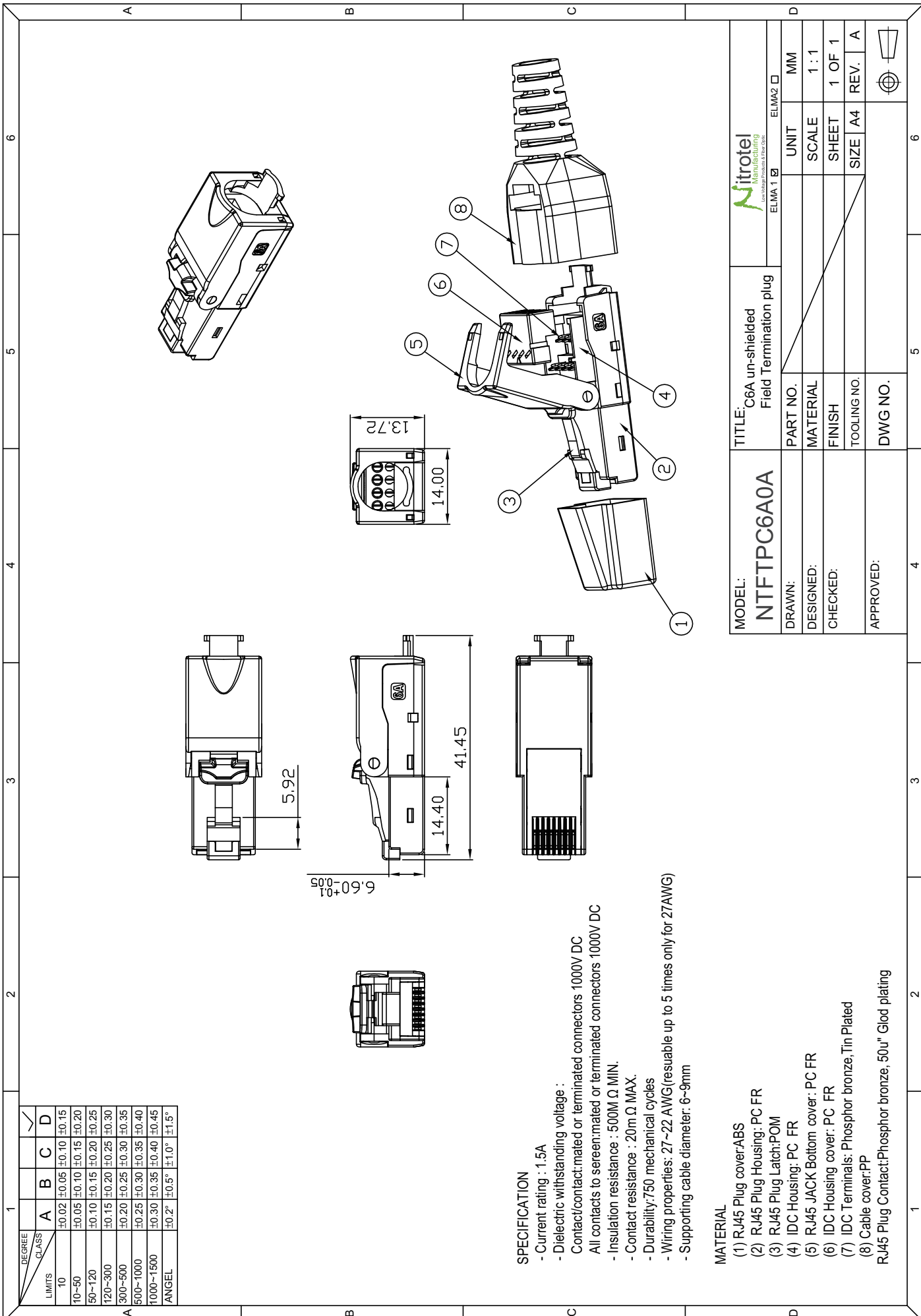

DEGREE CLASS	✓			
	A	B	C	D
LIMITS				
10	±0.02	±0.05	±0.10	±0.15
10~50	±0.05	±0.10	±0.15	±0.20
50~120	±0.10	±0.15	±0.20	±0.25
120~300	±0.15	±0.20	±0.25	±0.30
300~500	±0.20	±0.25	±0.30	±0.35
500~1000	±0.25	±0.30	±0.35	±0.40
1000~1500	±0.30	±0.35	±0.40	±0.45
ANGEL	±0.2°	±0.5°	±1.0°	±1.5°

SPECIFICATION

- Current rating : 1.5A
- Dielectric withstanding voltage : Contact/contact:mated or terminated connectors 1000V DC All contacts to screen:mated or terminated connectors 1000V DC
- Insulation resistance : 500M Ω MIN.
- Contact resistance : 20m Ω MAX.
- Durability:750 mechanical cycles
- Wiring properties: 27~22 AWG(resuable up to 5 times only for 27AWG)
- Supporting cable diameter: 6~9mm

MATERIAL

- (1) RJ45 Plug cover:ABS
- (2) RJ45 Plug Housing: PC FR
- (3) RJ45 Plug Latch:POM
- (4) IDC Housing: PC FR
- (5) RJ45 JACK Bottom cover: PC FR
- (6) IDC Housing cover: PC FR
- (7) IDC Terminals: Phosphor bronze, Tin Plated
- (8) Cable cover:PP

RJ45 Plug Contact:Phosphor bronze, 50u" Glod plating

MODEL:	NTFTPC6A0A	TITLE: C6A un-shielded Field Termination plug	
DRAWN:		PART NO.:	ELMA 1 <input checked="" type="checkbox"/> ELMA2 <input type="checkbox"/>
DESIGNED:		MATERIAL:	UNIT MM
CHECKED:		FINISH:	SCALE 1 : 1
APPROVED:		TOOLING NO.:	SHEET 1 OF 1
		DWG NO.:	SIZE A4 REV. A

Instruction Manual

①

Insert cable into strain relief boot, strip off 1.2 inch of cable jacket.

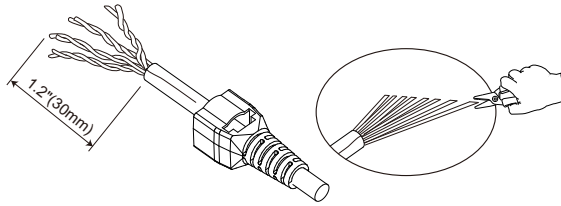

JACK PIN DESIGNATIONS	TIA / EIA T568A	TIA / EIA T568B	INDUSTRIAL
	1	White/Green	White/Orange
2	Green	Orange	Orange
3	White/Orange	White/Green	White
6	Orange	Green	Blue
4	Blue	Blue	
5	White/Blue	White/Blue	
7	White/Brown	White/Brown	
8	Brown	Brown	

②

Fan out all four twisted pairs, following the color coding label and allocate each conductors into proper slots on wiring cap. Trim the ends of conductors.

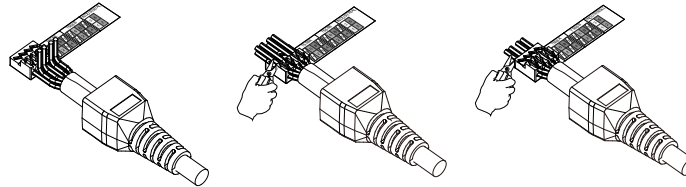

③

Remove the wiring label before place wiring cap on plug.

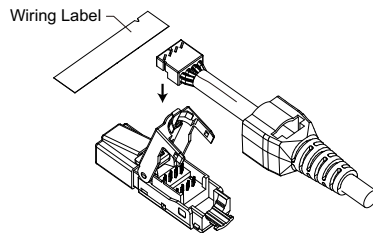

④

Place the wiring cap onto plug, use plier to clamp wiring cap until it completely snap-in to effect the connection.

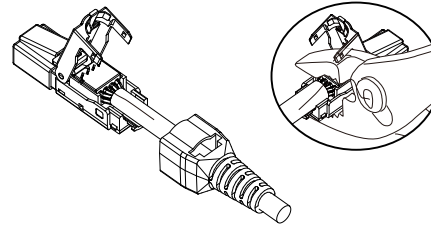

⑤

Close plug cover. Pull back strain relief boot to cover the plug, fasten supplied cable tie to secure cable with boot.

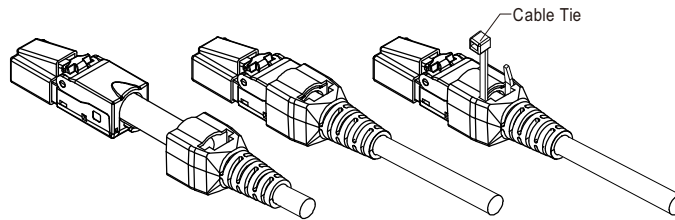

Unload the cable

Cut off cable tie, remove the boot. Using flat screw driver and pry gently on plug cover one end first and the other end subsequently to open it.

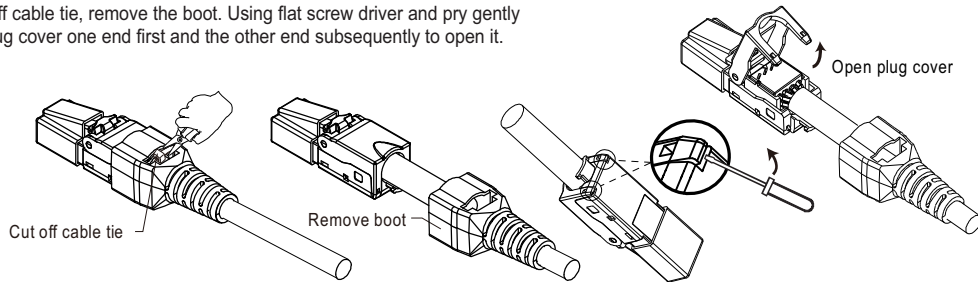

Boot adjustment

Cut the end of boot to fit your cable OD.

